

INSTALLATION

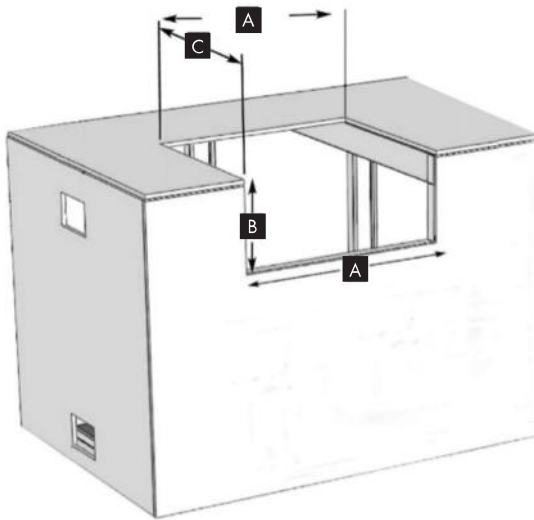

CUT OUT DIMENSIONS

Grill Model	A: Width	B: Depth	C: Height
Sizzler Pro 32"	30 3/4	20 3/4	8 1/2
Sizzler Pro 40"	38	20 3/4	8 1/2

OVERALL PRODUCT DIMENSIONS

Grill Model	A: Width	B: Depth	C: Height	Height-Hood Open
Sizzler 32"	32 1/2	25 1/2	20	30
Sizzler 40"	39 1/2	25 1/2	20	30

ALL BBQ ISLANDS MUST BE MANUFACTURED FROM "NON COMBUSTIBLE" MATERIAL. IF COMBUSTIBLE MATERIAL IS BEING USED, A SUMMERSET GRILL LINER IS REQUIRED.

NOTE:

For the minimum clearances between the grill and any side or rear walls, your setup must fall within one (or more) of the following:

IMPORTANT NOTES:

Clearance between grill and strictly non-combustible wall (i.e. brick wall, Clearance Fig. 1). The grill must have a minimum of 4" right, left and rear clearance from any non-combustible wall. This allows for proper ventilation and helps prevent dangerous overheating.

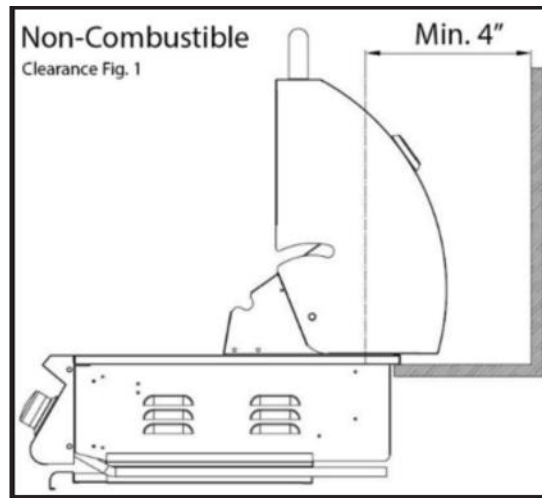

Clearance between grill and protected combustible wall (i.e. a non-combustible wall in front of a combustible wall to serve as a barrier. This can be accomplished by brick or a metal stud finished with non-combustible substrate. Clearance Fig. 2). The grill must have a minimum of 14" right, left and rear clearance from the protected combustible wall. (The 4" non-combustible material clearance, plus an additional 10" clearance between the grill and protected wall.)

