

MODERN  FLAMES

Sedona Pro Multi

SPM-3026 • SPM-3626 • SPM-4226 • SPM-5426



INSTALLATION/OWNERS MANUAL
FOR USE IN UNITED STATES AND CANADA

MODERN FLAMES

**SEDONA PRO MULTI
SPM-3026 • SPM-3626 • SPM-4226 • SPM-5426
SAFETY INFORMATION AND OPERATIONS MANUAL**

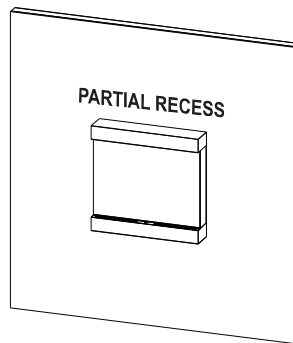
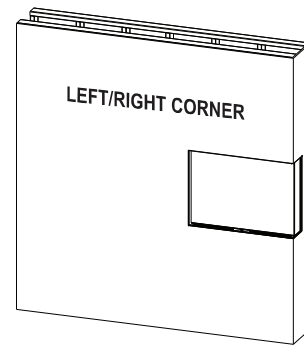
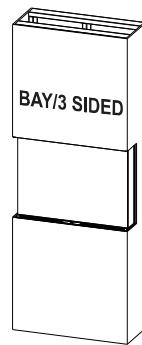
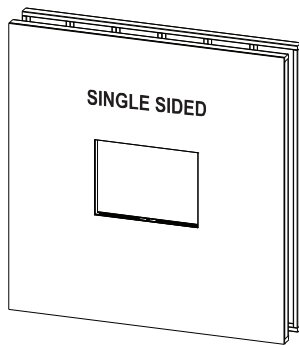

Read these instructions completely before beginning installation. Failure to follow them could cause a heater malfunction resulting in serious injury and/or property damage.

WARNING: All electric heaters have hot and arcing or sparking parts inside. Do not use it in areas where gasoline, paint or flammable liquids are or are stored.

This fireplace meets the construction and safety standards of H.U.D. for application in manufactured homes when installed according to these instructions.

INSTALLER: Leave this manual with the appliance.

USER INSTRUCTIONS

TABLE OF CONTENTS

Important Instructions.....	3	Service Parts.....	13
Power Data.....	4	Troubleshooting.....	15
Product Guide.....	4	Frequently Asked Questions.....	16
Box Contents.....	5	Cleaning and Maintenance Instructions.....	17
Installation.....	6	Wiring Diagram.....	17
Operation.....	12		

IMPORTANT INSTRUCTIONS

When using electrical heaters, basic precautions should always be followed to reduce the risk of fire, electric shock and injury to persons, including the following:

WARNING: Improper installation, adjustment, alteration, service or maintenance can cause injury or property damage. Refer to this manual. For assistance or additional information, consult a qualified installer.

CAUTION: Do not expose the heater to the elements (such as rain, etc).

Do not place clothing or other flammable material on or near firebox. Never place any objects on the fireplace.

Carefully supervise young children when they are in the room with fireplace.

Fireplace becomes very hot when running. Keep children and adults away from hot surfaces to avoid burns or clothing ignition. Fireplace will remain hot for a time after shutdown. Allow surfaces to cool before touching.

1. Read all instructions before installing or using this heater.
2. This heater is hot when in use. To avoid burns, do not let bare skin touch hot surfaces. Keep combustible materials, such as furniture, pillows, bedding, papers, clothes, and curtains at least 3 feet (0.9m) from the front of the heater and keep them away from the sides and rear.
3. Extreme caution is necessary when any heater is used by or near children or disabled people and whenever the heater is left operating and unattended.
4. Do not operate any heater after it malfunctions, has been dropped, or damaged in any manner. Disconnect power at service panel and have heater inspected by an authorized technician or a reputable electrician before using.
5. Do not use outdoors.
6. To disconnect heater, turn controls to off and turn off power to heater circuit at main disconnect panel.
7. Do not insert or allow foreign objects to enter any ventilation or exhaust opening as this may cause an electric shock or fire, or damage the heater.
8. To prevent a possible fire, do not block air intakes or exhaust in any manner.
9. A heater has hot and arcing or sparking parts inside. Do not use it in areas where gasoline, paint or flammable vapors or liquids are used or stored.
10. Use this heater only as described in this manual. Any other use not recommended by the manufacturer may cause fire, electric shock or injury to persons.
11. SAVE THESE INSTRUCTIONS



CAUTION: In order to avoid

USER INSTRUCTIONS

POWER DATA

	SPM-3026	SPM-3626	SPM-4226	SPM-5426
Volts/HZ Amps	AC 120V 60Hz 14 Amps	AC 120V 60Hz 14 Amps	AC 120V 60Hz 14 Amps	AC 120V 60Hz 14 Amps
Heater	AC 120V 1500W	AC 120V 1500W	AC 120V 1500W	AC 120V 1500W
Lamps	LED 12V	LED 12V	LED 12V	LED 12V
Rotor Motor	AC120V/60Hz 40mA 3.7W 40mA 3.0W 18/15RPM CCW	AC120V/60Hz 40mA 3.7W 40mA 3.0W 18/15RPM CCW	AC120V/60Hz 40mA 3.7W 40mA 3.0W 18/15RPM CCW	AC120V/60Hz 40mA 3.7W 40mA 3.0W 18/15RPM CCW
Shipping Size	33 ¼" x 38 ¼" x 15 ½"	39 ¼" x 38 ¼" x 15 ½"	45 ¼" x 38 ¼" x 15 ½"	57 ¼" x 38 ¼" x 15 ½"

PRODUCT GUIDE

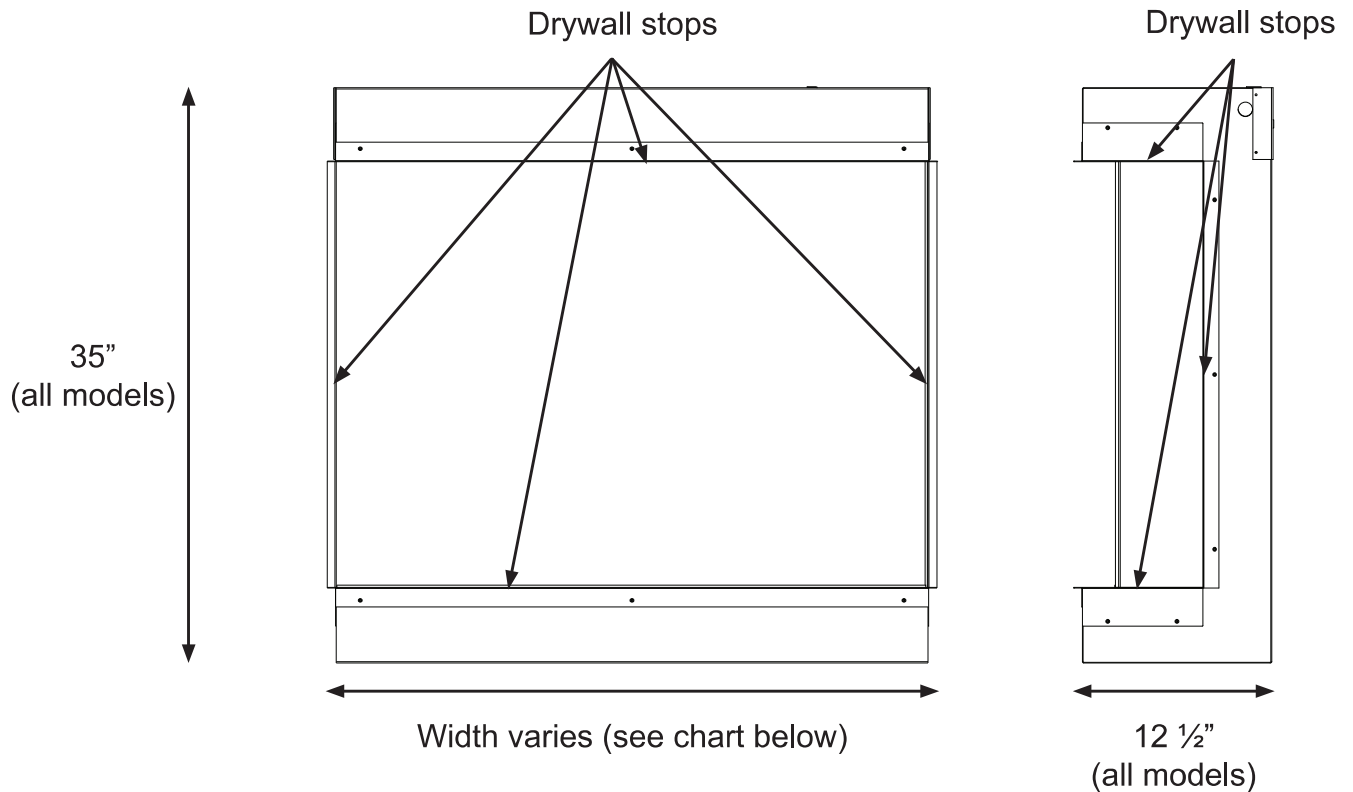

Model	Viewing Area	Firebox Dimensions	Framing Dimensions
SPM-3026	29 ⅞" W x 26" H	30" W x 35" H x 12 ½" D	30 ¼" W x 35 ⅜" H x 13" D
SPM-3626	35 ⅞" W x 26" H	36" W x 35" H x 12 ½" D	36 ¼" W x 35 ⅜" H x 13" D
SPM-4226	41 ⅞" W x 26" H	42" W x 35" H x 12 ½" D	42 ¼" W x 35 ⅜" H x 13" D

INSTALLATION

BOX CONTENTS

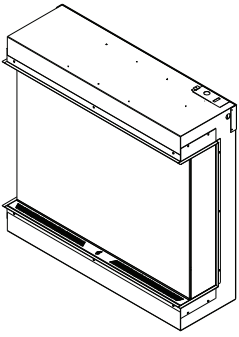

1 Fire Unit



1 Remote

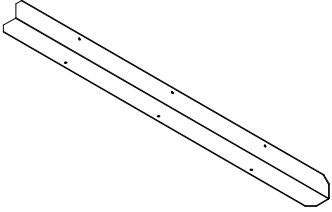

L-Metal Mounting
Brackets



2 Side Covers

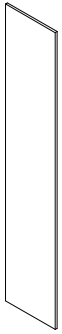

2 Side Glass Pieces

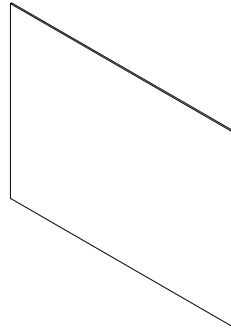

1 Front Glass

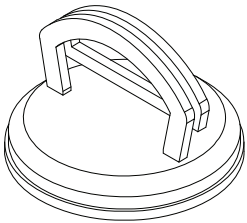

2 Suction Cups

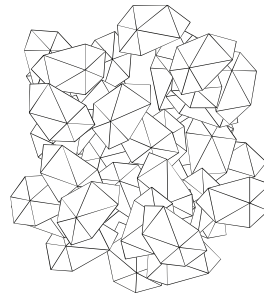

Smoke Acrylic
Crystals

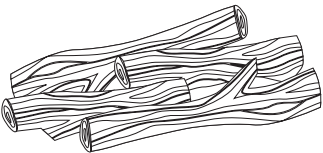

Canyon Driftwood
Logs



1 Owner's Manual

INSTALLATION

INSTALLATION

WARNING: If the information in these instructions is not followed exactly, a fire or explosion may result causing property damage, personal injury or death.

WARNING - RISK OF FIRE!

To prevent a possible fire, do not block air intake or exhaust in any manner. Do not use on soft surfaces where openings may become blocked.

WARNING - RISK OF FIRE!

Do not blow or place insulation against the firebox.

To reduce the risk of fire do not store or use gasoline or other flammable vapors in the vicinity of this or any other heater.

CAUTION: Keep combustible materials, such as furniture, pillows, bedding, papers, clothes and curtains at least 3 feet (0.9m) from the front of the heater and keep them away from the sides and rear.

CAUTION: Wear gloves and safety glasses for protection during installation and maintenance.

Installing fireplace

Select a suitable location that is not susceptible to moisture and is a safe distance from drapes, furniture and high traffic areas. **A qualified electrician should add a dedicated flexible 20 amp 120 volt circuit per local building codes.**

Note: Follow all national and local electrical codes.

This fireplace has a number of installation options. It can be installed fully recessed, half recessed, wall mounted with a floating cabinet or with a simple slide-in cabinet. In addition, the fully recessed option can be installed with all sides showing, 1 side showing, or flush.

To prepare for installation, connect the hard wire to the terminal block located on top back right of fireplace according to the diagram below. Choose any connector type according to local building code.

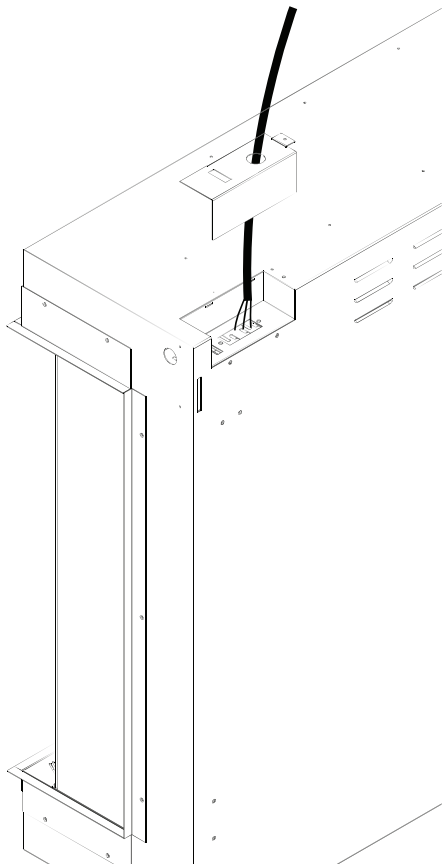

To be performed by a qualified electrician according to local building codes.

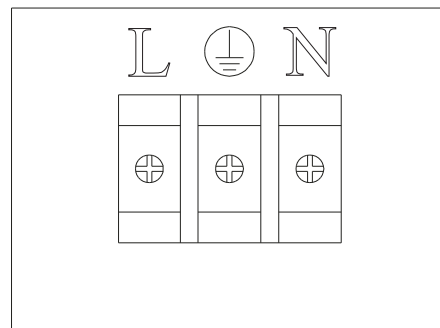
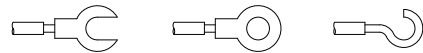

L - Line

⊕ - Ground

N - Neutral

INSTALLATION

Framing Dimensions

Model	W	H	D
SPM-3026	30 ¼"	35 ⅜"	13"
SPM-3626	36 ¼"	35 ⅜"	13"
SPM-4226	42 ¼"	35 ⅜"	13"
SPM-5426	54 ¼"	35 ⅜"	13"

1. Prepare the framed opening according to the chart above. *Provide appropriate dedicated circuit for hardwire install at the top right of framed opening.

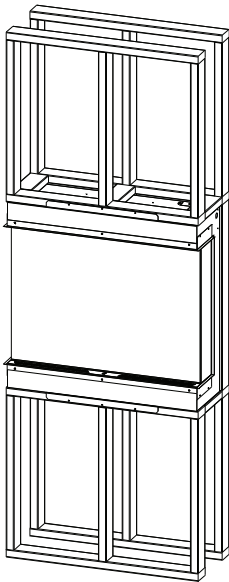

3 Sided Installation (Bay)

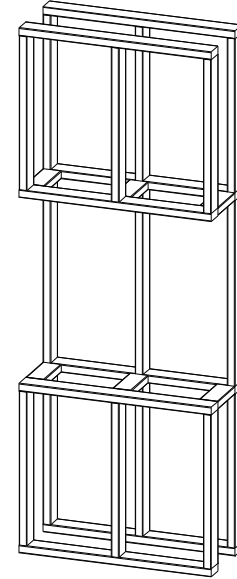

2. Install L Metal Nailing Flanges to the top and bottom of the fire unit.
3. Install the fire unit in the framed opening with a minimum 1 ¼ drywall screws to secure the unit.

4. **Mask the exposed fire unit during the drywall process.** Install drywall to the drywall stops on the perimeter of the fire box. For more information on the drywall stops see the Product Guide on page 4.
5. Decorate according to media installation guide on page 10.
6. Install the side and front glass pieces according to installation diagram on Page 11.

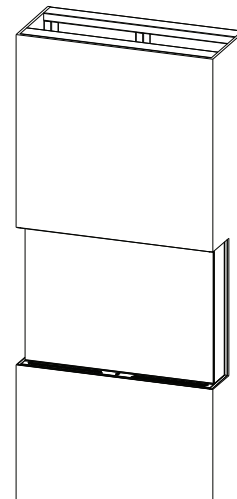

Fully Recessed Installation (Left/Right Corner)

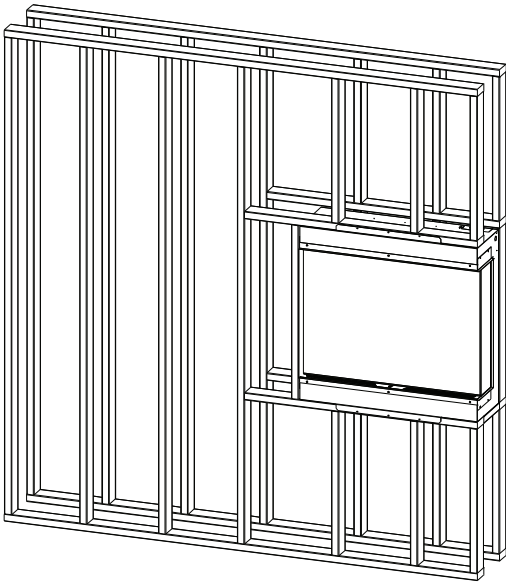

4. Install the fire unit in the framed opening with a minimum 1 ¼ drywall screws to secure the unit.
5. **Mask the exposed fire unit during the drywall process.** Install drywall to the drywall stops on the perimeter of the fire box. For more information on the drywall stops see the Product Guide on page 4.
6. Decorate according to media installation guide on page 10.
7. Install the remaining side glass and front glass according to installation diagram on Page 11.

Fully Recessed Flush Installation (Single Sided)

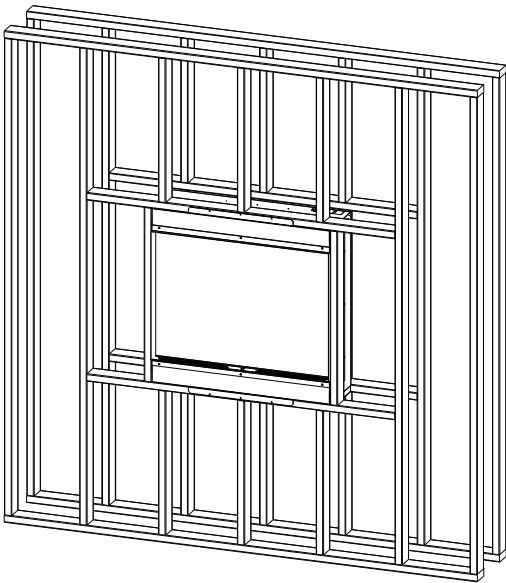

5. **Mask the exposed fire unit during the drywall process.** Install drywall to the drywall stops on the perimeter of the fire box. For more information on the drywall stops see the Product Guide on page 4.
6. Decorate according to media installation guide on page 10.
7. Install the front glass according to installation

1. Follow steps 1 & 2 from the 3 sided installation instructions.
2. Remove the corresponding drywall stops according to your installation (in the example, the drywall stops on the left end would be removed.)
3. Install the side glass then the corresponding side cover according to your installation (**the side glass must be installed before the metal side cover.** See installation diagram on Page 11.)

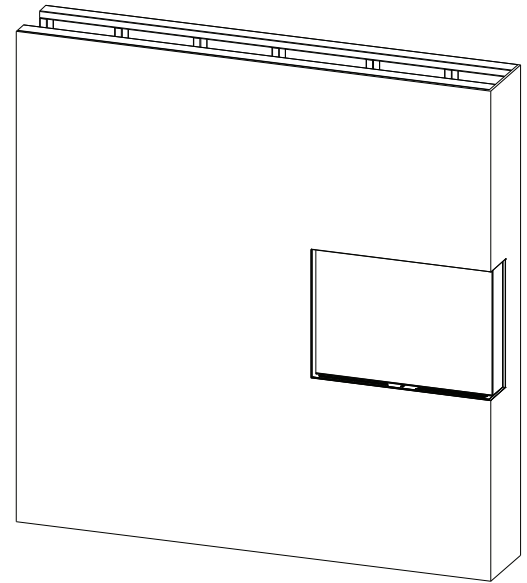

1. Follow steps 1 & 2 from the 3 sided installation instructions.
2. Remove the drywall stops on both sides of the fire unit.
3. Install the side glass then side covers on both sides of the fire unit (**the side glass must be installed before the metal side cover.** See installation diagram on Page 11.)
4. Install the fire unit in the framed opening with a minimum 1 ¼ drywall screws to secure the unit.

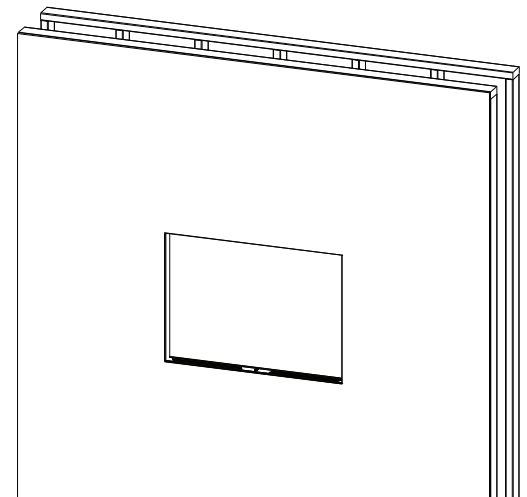

INSTALLATION

Partial Recess Installation

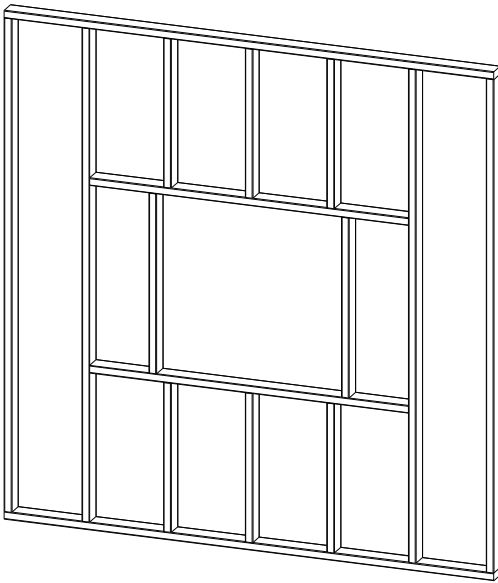

1. This installation is optimized for a 2x6 framed wall. Prepare the framed opening according to the height and width of the chart on page 7. *Provide appropriate dedicated circuit for hardwire install at the top right of framed opening.

2. Install L Metal Nailing Flanges to the top and bottom of the fire unit.
3. Install the fire unit in the framed opening with a minimum 1 ¼ drywall screws to secure the unit.

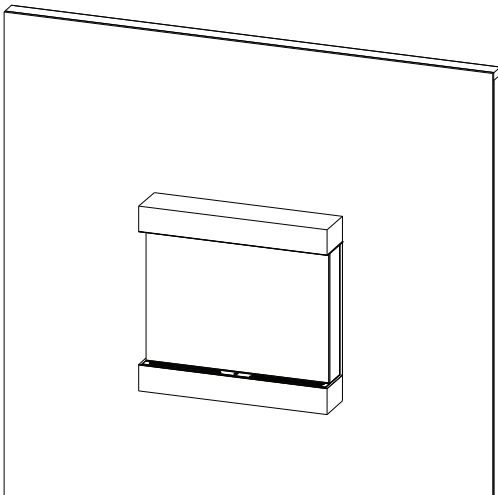
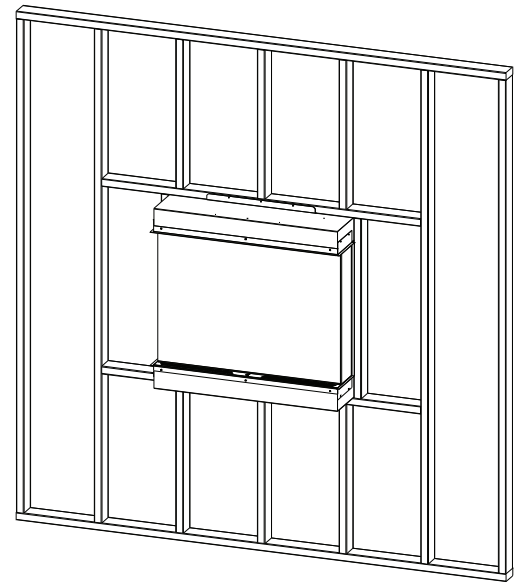

4. **Firebox must be covered with material of choice. Mask the exposed fire unit during this process.** Install drywall, tile or material of your choice to the drywall stops on the perimeter of the fire box. For more information on the drywall stops see the Product Guide on page 4.
5. Decorate according to media installation guide on page 10.
6. Install the side and front glass pieces according to installation diagram on Page 11.

Installing Media

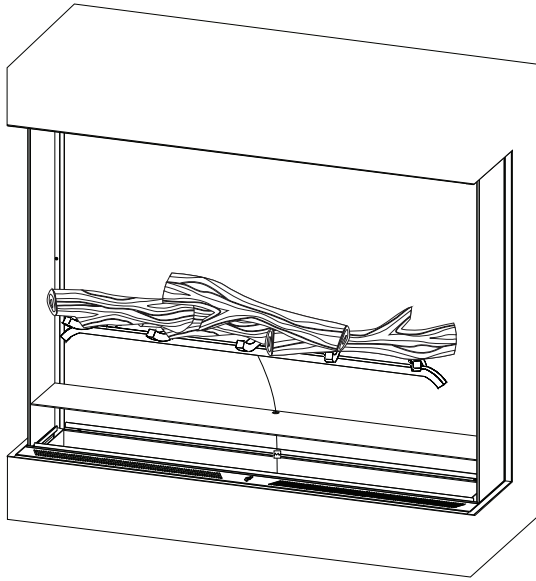

1. Before installing the front glass, connect the logset to the electrical connection below the ember bed poly screen. The electrical connection can be routed through the hole on the back side of the ember bed.

2. Evenly spread out the acrylic crystals along the ember bed.

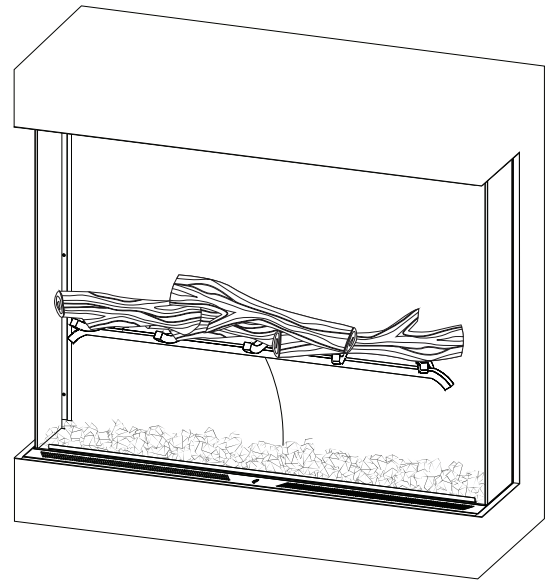

3. Place the logset on top of the acrylic crystals.
4. The front glass can now be installed.

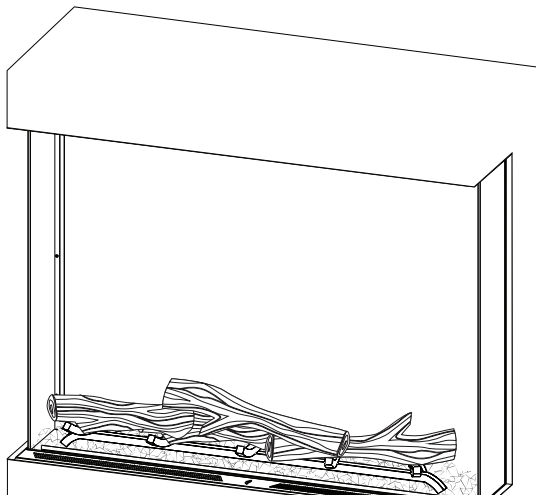

INSTALLATION

Installing Side Glass

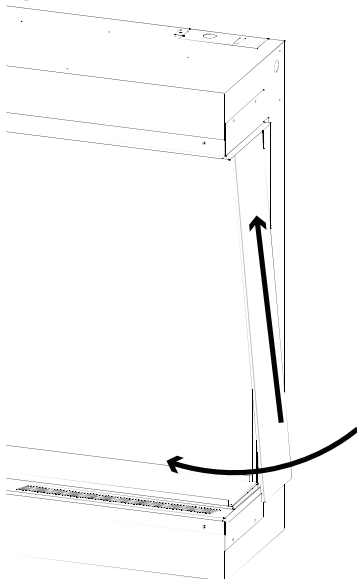

Figure 1.1

1. The unit has 2 channels on the top and bottom to hold the side glass.
2. Insert the glass at an angle in to the top channel.
3. Swing the bottom edge of the side glass in to the unit. See Figure 1.1.

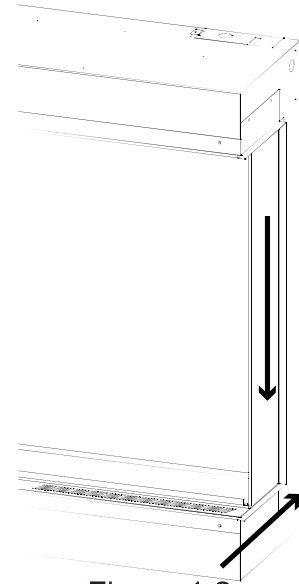

Figure 1.2

4. Slide the glass down in to the bottom channel.
5. Push the glass back as far as it will go to make installation of the front glass easier. See Figure 1.2.

Installing Front Glass

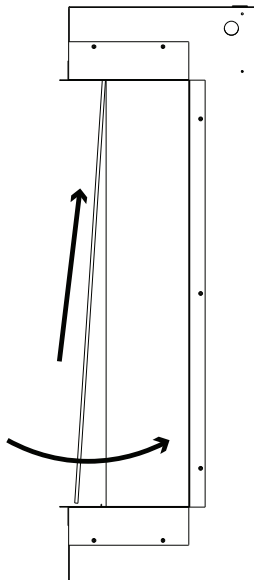
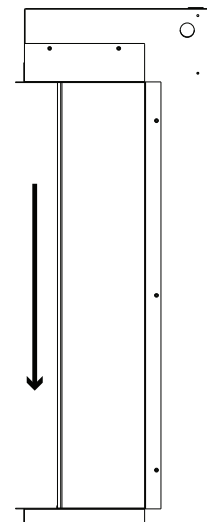

Figure 2.1











1. The unit has 2 channels on the top and bottom to hold the front glass.
2. Using the included suction cups, insert the glass at an angle in to the top channel.
3. Swing the bottom edge of the front glass in to the unit. See Figure 2.1.

4. Slide the glass down in to the bottom channel. See Figure 2.2



OPERATION

The unit has a main power switch just in front of the glass on the top right hand side. A hand-held remote is included.









-  **Power** This will cycle the machine on and off. Upon cycling power on, the machine will return to the settings it had when it was cycled off.
-  **Reset** If the fireplace is on, this button will act as a reset and bring all colors back to the default Modern Flames' signature color.
-  **Heat** This will cycle the heater between high, low and off.
-  **Fade** All zones of the fireplace will cycle through various demo modes - 7 & 3 color gradient/fade, 7 & 3 color jump, red/green/blue gradient.
-  **Sync** Pressing the sync button will change all the colors of the fireplace (Flame, Ember Bed and Downlight) to match the current color of the flame setting.
-  **Flame** This is a zone setting. Touching this button will allow you to change the color and brightness of the flame by using the color wheel and brightness slider.
-  **Ember Bed** This is a zone setting that controls the color and brightness of the ember bed.
-  **Downlight** This is a zone setting that controls the color and brightness of the downlight.
-  **Color Wheel** This will cycle the selected zone through the colors of the color spectrum.
-  **Brightness Slider** This will adjust the brightness of the selected zone.



Pairing remote/wall mounted touch control:





1. With the fireplace ON press and hold the Power button for about 3 seconds until you hear the buzzer sound twice and the power indicators begin to flash.
 2. Within 5 seconds on the hand held remote or wall touch control press the Power button repeatedly until the buzzer sounds again and the indicators flash acknowledging that it has paired. You may also hear another buzzer and the pair is now completed.
- Pairing must be done within 5 seconds or the fireplace will time out of pairing mode.
 - To clear any paired remotes from the unit, locate then press and hold the reset button for 3 seconds. You should hear a buzzer letting you know the codes have been cleared so you can now pair a new remote or wall touch control. (The reset is located next to the manual controls and can be pressed with a paper clip.)

Power indicator lights for wall switch as well as upper left corner of the main unit

-   
When the switch turns on, this orange pilot lamp turns on. It shows the fire is energized.
-   
The status light above shows that the power is on and the heater is on low.
-   
The status light above shows that the power is on and the heater is on high.



Manual Controls

The unit has manual controls located just in front of the glass on the top left side.

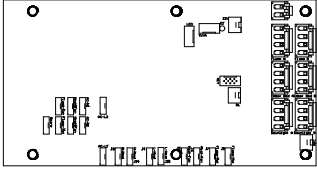
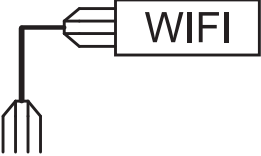
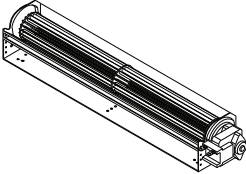
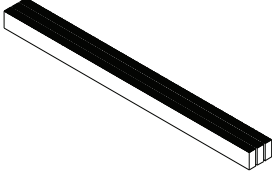
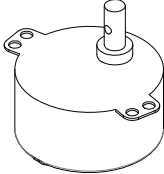

-  **Power**
Turns unit on/off
-  **Heat**
Cycles heat low/high/off
-  **Color**
Changes all fireplace
-  **Reset**
Resets unit

MAINTENANCE

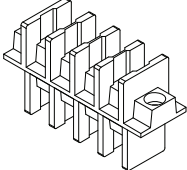
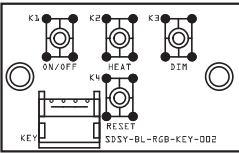
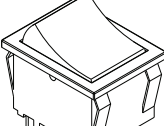
SERVICE PARTS

ITEM	PHOTO	DESCRIPTION
MF-PRO-PCB		PRINTED CIRCUIT BOARD CONTROLS LOW VOLTAGE AND HIGH VOLTAGE FUNCTIONS AND TRANSFORMER
MF-PRO-WIFI		WIFI BOARD
MF-PRO-HF		HEATER FAN 120 V
MF-PRO-PTC		PTC HEATER 120V 750/1500 WATTS
MF-PRO-RC		SPINDLE MOTOR 120 V 50-60 HZ
MF-PRO-RC		PRO SERIES RF REMOTE CONTROL
MF-PRO-WTC		<p style="text-align: center;">OPTIONAL WALL MOUNTED TOUCH CONTROL ASSEMBLY</p>
MF-PRO-TB		TERMINAL BLOCK 120/240 V
MF-SPRO-MTC		MANUAL TOUCH CONTROL BOARD
MFPS2		20 AMP POWER SWITCH

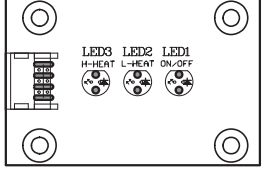
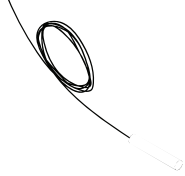
SERVICE PARTS

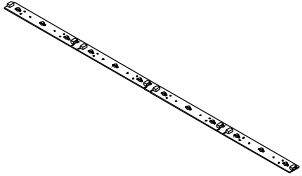
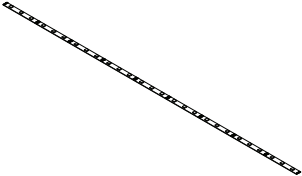
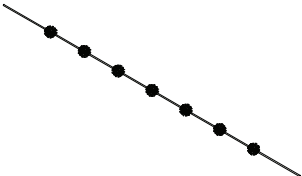
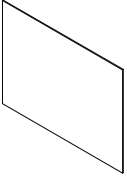
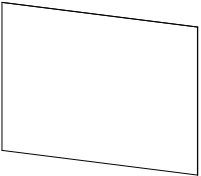
ITEM	PHOTO	DESCRIPTION
MF-PRO-PIB		POWER INDICATOR BOARD
MF-PRO-NTC		THERMOSTAT SENSOR
MF-SPM-SG-C		SIDE GLASS CLEAR
MF-SPM-F/LED-30		RGB FLAME LED BAR SET
MF-SPM-F/LED-36		
MF-SPM-F/LED-42		
MF-SPM-F/LED-54		
MF-SPM-EB/DL-30		RGB EMBER BED/DOWNLIGHT LED STRIP
MF-SPM-EB/DL-36		
MF-SPM-EB/DL-42		
MF-SPM-EB/DL-54		
MF-SPM-SR-30		SPINDLE ROD FOR FLAME AND EMBER BED
MF-SPM-SR-36		
MF-SPM-SR-42		
MF-SPM-SR-54		
MF-SPM-GF-30		FRONT GLASS
MF-SPM-GF-36		
MF-SPM-GF-42		
MF-SPM-GF-54		
MF-SPM-PP-30		FLAME SCREEN
MF-SPM-PP-36		
MF-SPM-PP-42		
MF-SPM-PP-54		

MAINTENANCE

TROUBLESHOOTING

Problem	Possible Cause	Corrective Action
Nothing comes on (touch screen, etc.)	A. Breaker tripped or circuit has no power	A. Reset breaker, test circuit for power, check power switch
	B. Internal component is frozen and needs to be reset	B. Turn power off at the main breaker for 60 seconds. Turn power back on.
	C. Loose connection	C. Inspect wiring for loose or damaged connection
	D. Defective component	D. Replace motherboard, touch control or power switch
Touch Screen Comes on - then nothing	A. Not operating touch control properly with finger	A. Press flat part of finger firmly on the touch screen and apply moderate pressure
	B. Loose connection on motherboard	B. Check functions with remote control. If functional, check connections on motherboard
	C. Motherboard is defective	C. Replace Motherboard
Fireplace turns off and will not turn back on	A. Fireplace has overheated and safety disc has snapped or circuit breaker has tripped	A. Turn the main breaker to the "off" position for 60 seconds. Next flip the breaker back into the "on" position.
Can operate fireplace functions with manual controls but not remote control	A. Low Batteries	A. Replace batteries in remote control with - CR2025
	B. Remote not paired properly	B. With the fireplace ON press and hold the Power button for about 3 seconds until you hear the buzzer sound twice and the power indicators begin to flash. Within 5 seconds on the hand held remote or wall touch control press the Power button repeatedly until the buzzer sounds again and the indicators flash acknowledging that it has paired. You may also hear another buzzer and the pair is now completed.
	C. Remote control defective	C. Replace remote control
Heater does not provide heat when on	A. Wiring is loose	A. Disconnect unit from power source and inspect for loose connections
	B. Snap disc tripped	B. Turn off for 5 minutes to reset
	C. Heater core is defective	C. Replace Heater Core

MAINTENANCE

Problem	Possible Cause	Corrective Action
Flame is not visible when unit is turned on	A. Wiring is loose	A. Disconnect unit from power source and inspect for loose connections
	B. LEDs defective	B. Replace LEDs
	C. Motherboard is defective	C. Replace motherboard
Fireplace lights up but there is no flame image or flame image frozen	A. Wiring for motor is loose	A. Disconnect unit from power source and inspect for loose connections from motor
	B. Spindle rod came loose	B. Reconnect spindle rod
	C. Motor is defective	C. Replace motor
Fireplace is squeaking when flame image is on	A. Fireplace spindle/rod is contacting to metal	A. Apply lithium grease or any standard grease to contacts with rod and metal
	B. Motor is defective	B. Replace motor

FREQUENTLY ASKED QUESTIONS

Q. How do you change the optional Wall Touch Control to Fahrenheit/Celsius?

A. Long press on the up and down arrows on the fire unit to toggle between Fahrenheit and Celsius.

Q. What distance can the remote be used from the fireplace?

A. Optimal distance for the remote control is maximum 20 feet.

Q. Can you turn on the fireplace via the manual control and off via the remote (or vise versa)?

A. Yes.

Q. Can the fireplace be installed outside?

A. No. Please review the entire safety chapter before installing this fireplace.

Q. Does the fireplace need to be on a dedicated 20 amp circuit?

A. Yes.

Q. What thickness of sheetrock should be used for the recessed installation?

A. 1/2" or 5/8", thinner is recommended for tile façade.

Q. How often do the batteries in the remote need to be replaced?

A. Annually, possibly more with heavy use.

Q. Is there a remote receiver in the fireplace that requires batteries?

A. No, only the actual remote requires batteries. The rest of the fireplace runs entirely off of the main power supply.

Q. How do I reset the unit?

A. Turn power off at the breaker for 1 minute.

Q. How do I install the Optional Wall Control and Wi-Fi App?

MAINTENANCE

CLEANING AND MAINTENANCE INSTRUCTIONS

There is very little maintenance involved with your electric fireplace. Please follow the few points below:

- On a semi-annual basis unplug the machine from its power source, wait for the heating element to cool and dust the fire unit with a dry cloth. Be careful not to brush any wires that may be exposed as you do this.
- To clean the glass face of the fireplace simply use your desired glass cleaner with paper towels.
- To clean the air inlets/outlets, wipe with a soft cloth or the nozzle of a vacuum cleaner
- Dust can easily build up around the heater area inside the fire unit, on the left and right sides. Take particular care to clean this area on a regular basis to prevent buildup.
- For long periods of inactivity, please unplug the fireplace and ensure the surrounding area remains dry.

WIRING DIAGRAM

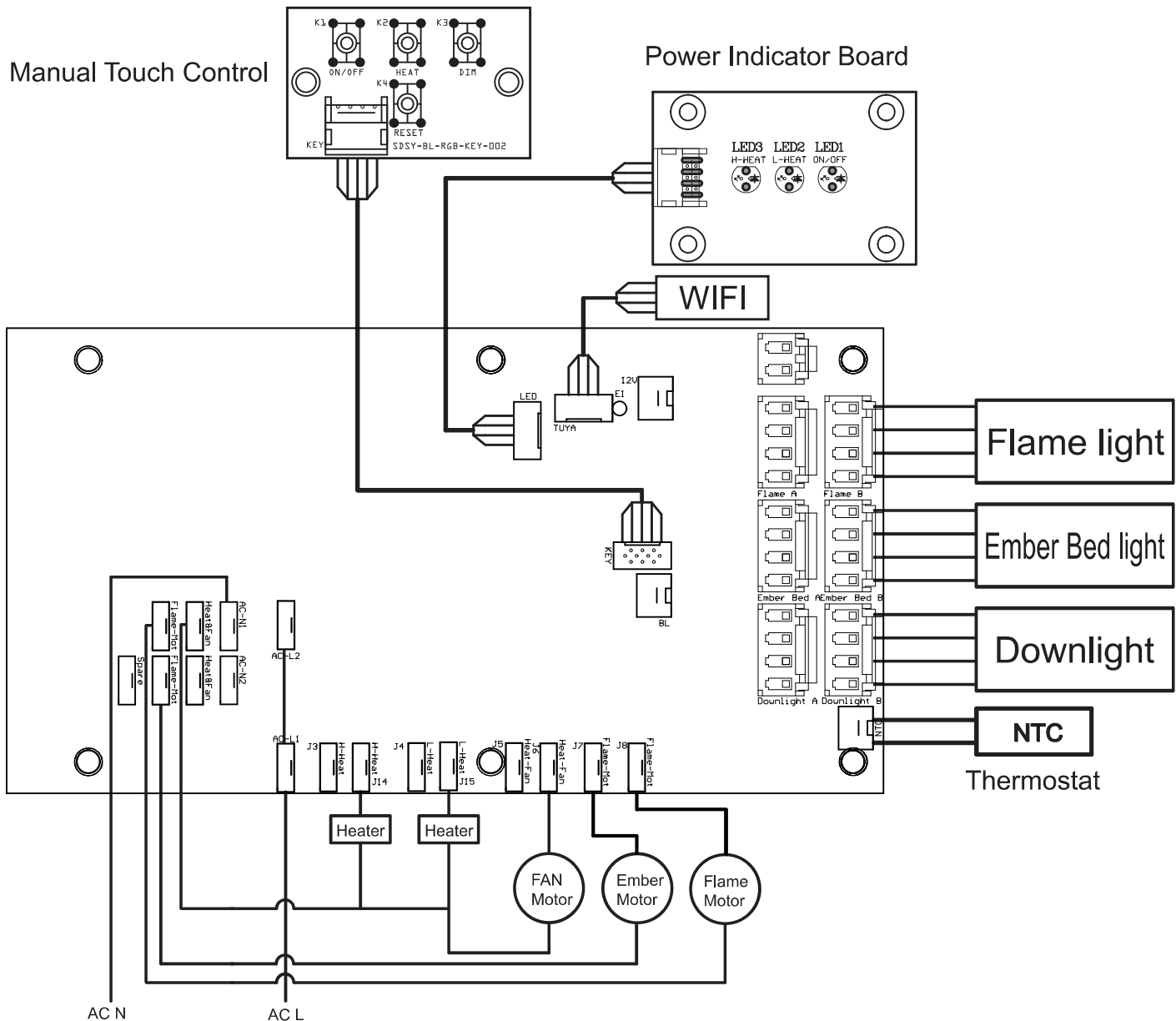

DO NOT RETURN TO STORE!



CALL US FIRST

For immediate help with installation, product information or if your product arrives damaged, please call our toll free number at:

1-877-246-9353

(Monday - Friday, 8:00AM - 5:00PM, AZ Mountain Time)

Or email us at:

customerservice@modernflames.com

OUR STAFF IS READY TO PROVIDE ASSISTANCE

©2019

MODERN  FLAMES

www.modernflames.com
Please dispose of properly.

